

SAFETY INFORMATION

Please read and understand this entire manual before attempting to assemble, install or operate the product.

WARNING

- RISK OF ELECTRIC SHOCK - Before beginning installation, turn off electricity at the circuit breaker box or the main fuse box.
- RISK OF FIRE - Use bulbs specified by the markings and/or labels on the fixture.

CAUTION

- For your safety, read instructions completely before beginning installation.
- If in doubt about electrical installation, consult a licensed electrician.
- Turn off electricity to fixture before replacing the bulb(s).

TOOLS REQUIRED

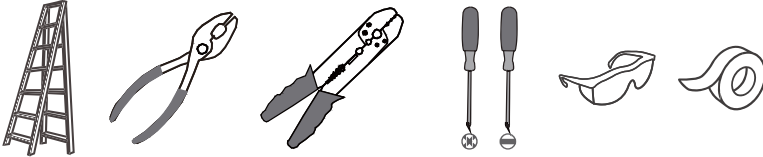

CARE AND MAINTENANCE

- Wipe clean using soft, dry cloth or static duster. Always avoid using harsh chemicals and abrasives to clean fixture as they may damage the finish.

If you need further assistance call Quozel Customer Care at 1-800-645-3184 (9:00am - 5:00pm EST), or visit us on-line at www.quezel.com.

PACKAGE CONTENTS

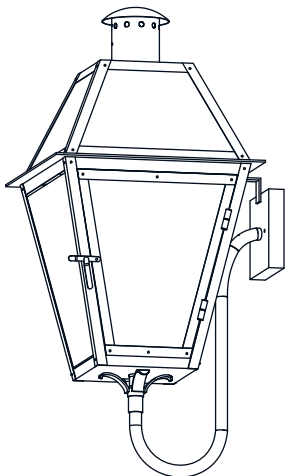

A Fixture Body
x 1



B Candle Cover
x 4

MOUNTING HARDWARE

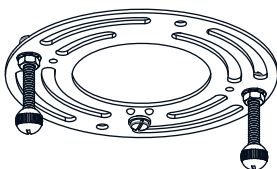

AA Crossbar Assembly
x 1



BB Alternate
Mounting Screw
x 2



CC Wire Connector
x 3



DD Outlet Box Screw
x 2

INSTALLATION

1 Install Crossbar Assembly

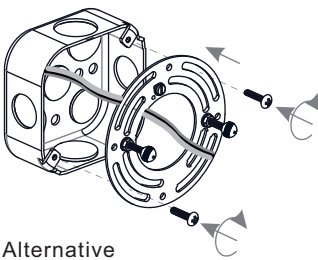

(2) Alternative Screws



* Alternative screws are provided to replace pre-assembled mounting screws if necessary.

2 Wiring

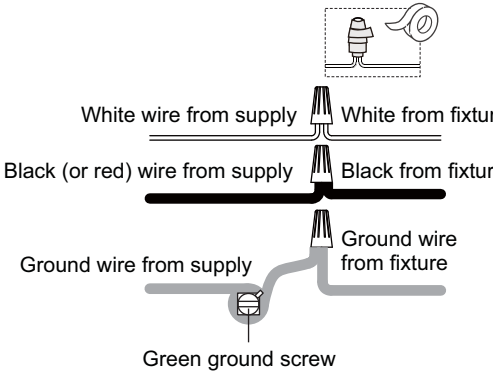

White wire from supply White from fixture

Black (or red) wire from supply Black from fixture

Ground wire from supply Ground wire from fixture

Green ground screw

3 Install Fixture Body

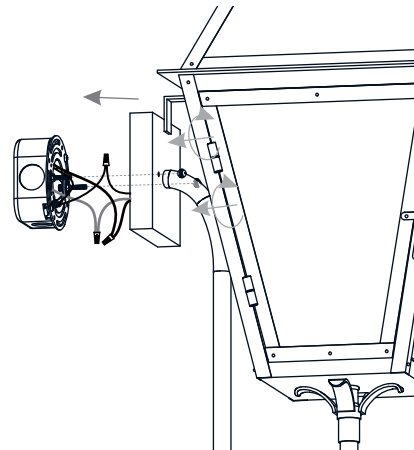

4 Remove Papers inside of the Cage

Remove door bolt from bolt holder

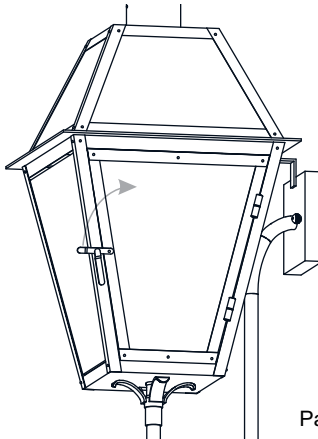

Open the door and remove paper inside

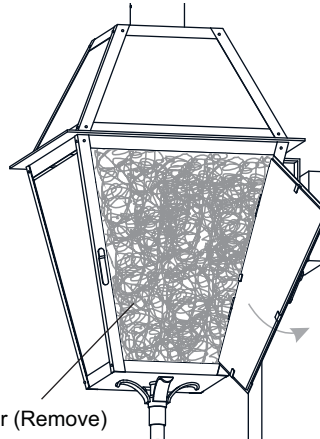

Paper (Remove)

5 Install Candle Covers and Bulbs

Install four correct bulbs referring to fixture markings and/or labels for maximum wattage.

Recommended Bulb Type (not included):

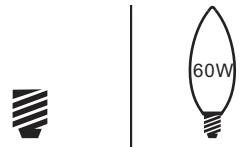

BULB BASE TYPE Candelabra (E12) BULB SHAPE TYPE B

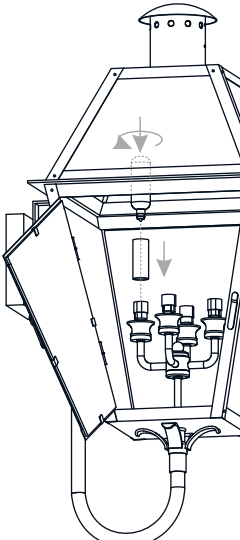

6 Close the Door

Close the door

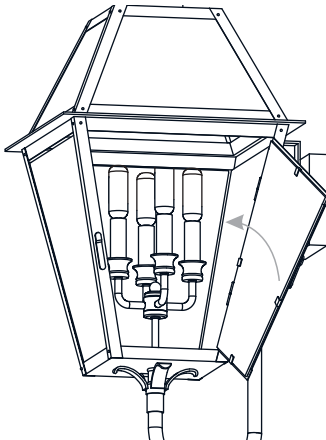

Place door bolt back onto bolt holder

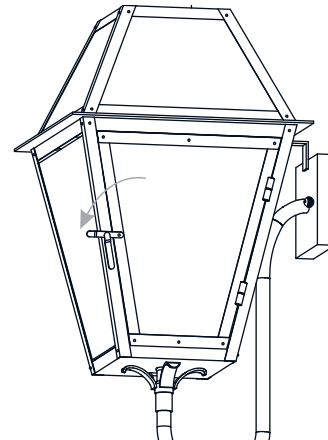

7 Apply Caulking

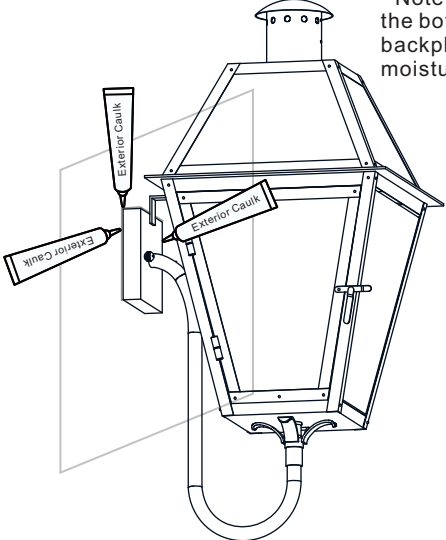

* Note: Do NOT caulk the bottom of the backplate to allow moisture to escape.

Your installation is now complete! Restore electricity and save this sheet for future reference.